



**Name Plaque
(with mood sign)**



Trophy and trinket shelf



Basic Picture Frames



Easel



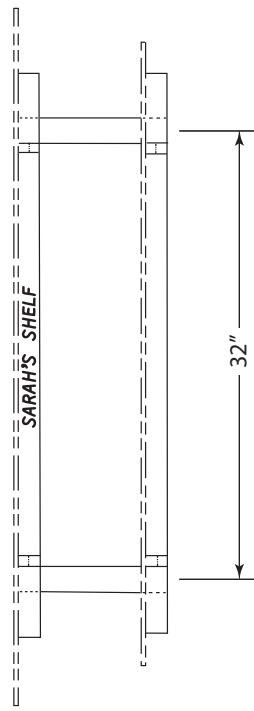
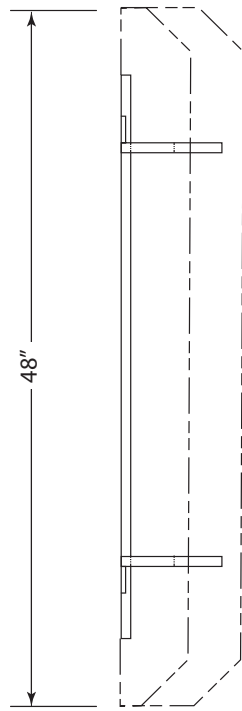
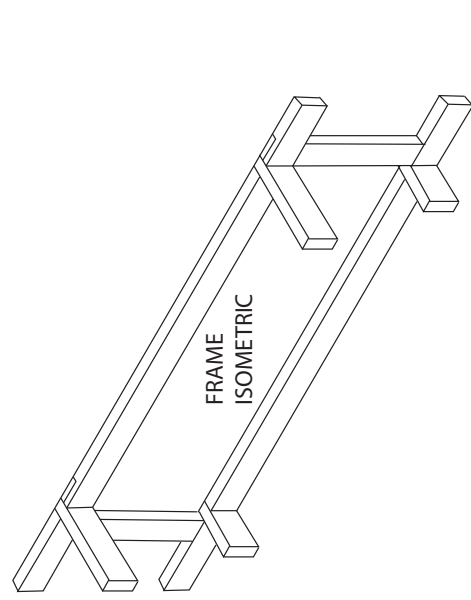

(USE A MULTIPLE OF 16" FOR EASY MOUNTING)

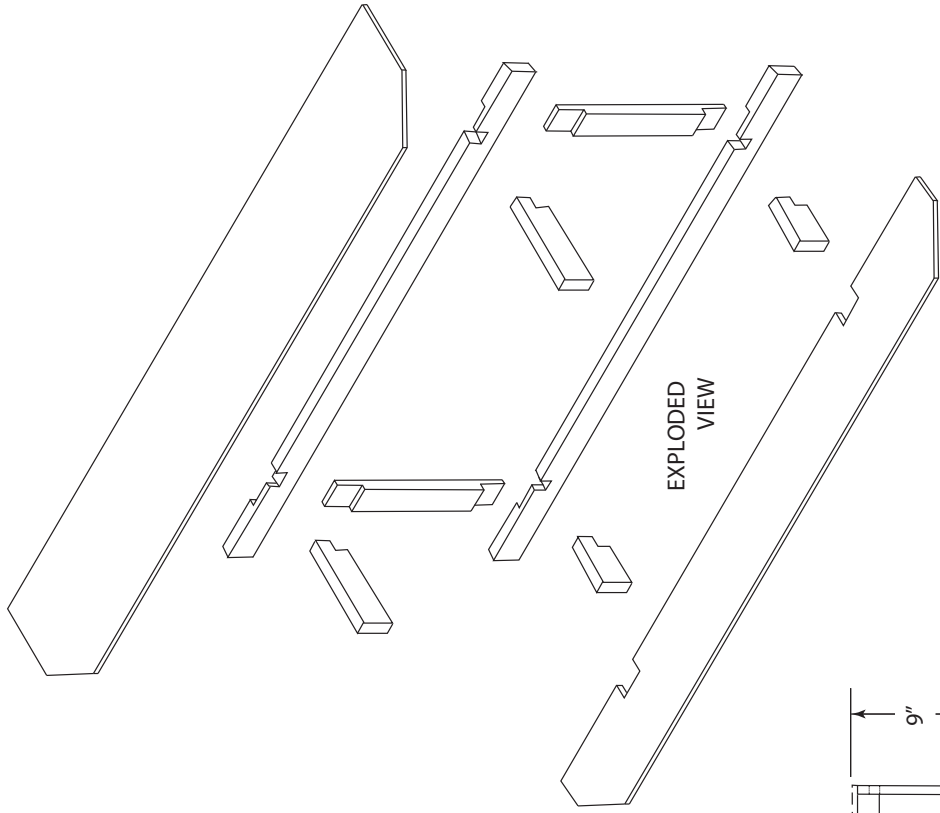
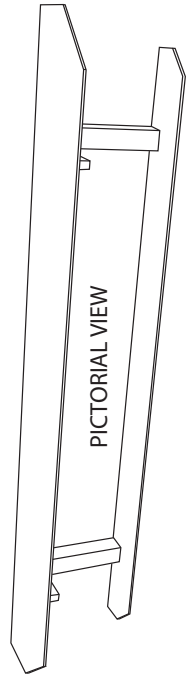

- NOTES:
- 1- DIMENSIONS SHOWN ARE WHAT I USED. NONE A CRITICAL.
 - 2- THIS DESIGN IS INTENTIONALLY VERY PLAIN. SCROLLING OR ROUTING EDGES CAN ADD A LOT OF STYLE THUS SHOULD BE CONSIDERED IN YOUR PROJECT.
 - 3- AROMATIC CEDAR AND REDWOOD MAKE AN INEXPENSIVE MATERIAL CHOICE.
 - 4- KIDS LOVE SEEING THEIR NAME AND THEY LOVE TO 'OWN' STUFF. THUS I ROUTED MY GRANDAUGHTERS NAME ON THE ONE I BUILT.

TROPHY SHELF
DR. BY: K RALSTON
2/14/21
WOODWORKINGGIFTS.COM

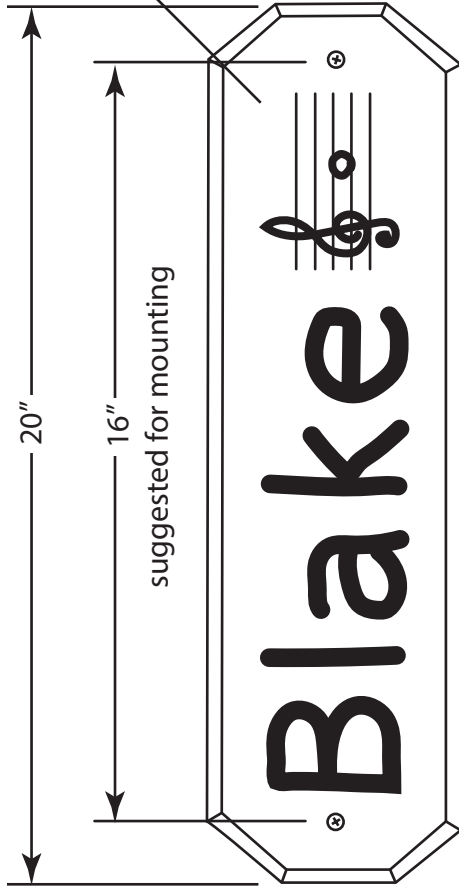

Do an image search in google for a whole world of possible image ideas.

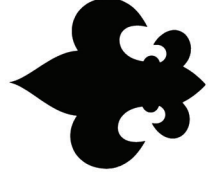
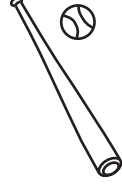

PERSONALITY IMAGE

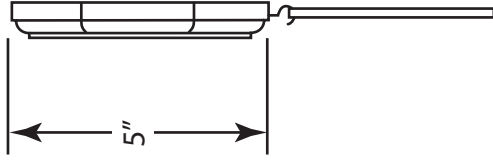

OPTIONAL MOOD SIGN

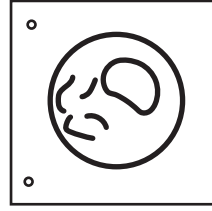
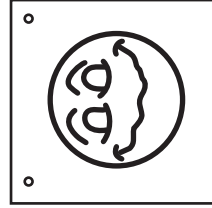
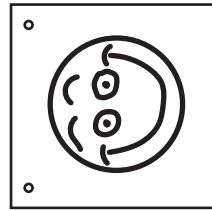
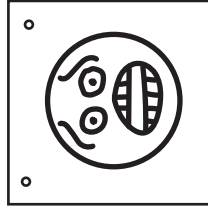
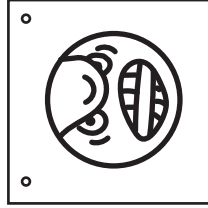
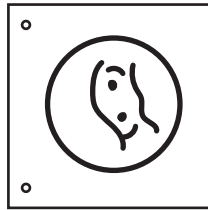
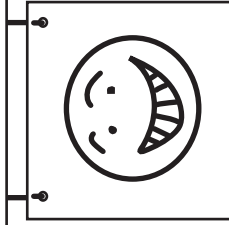

- NOTES:
- 1 - THIS IS A ROUTER PROJECT SHOWN WITH BEAD EDGE . OF COURSE THIS COULD BE AN OGEE, CHAMFER, COVE ETC..
 - 2 - USE ROUNDED BITS FOR LETTERING AND SELECTED DESIGN.
 - 3 - CHOSE A PERSONALITY IMAGE DESIGN THAT MATCHES THE PERSONALITY OF THE PERSON NAMED.
 - 4 - YOUNGER KIDS LOVE SEEING THEIR NAME.

NAME PLAQUE
DR. BY: K RALSTON
2/17/21

WOODWORKINGGIFTS.COM

Many options available. Do an image search for 'stick faces'.



Woodworkinggifts.com

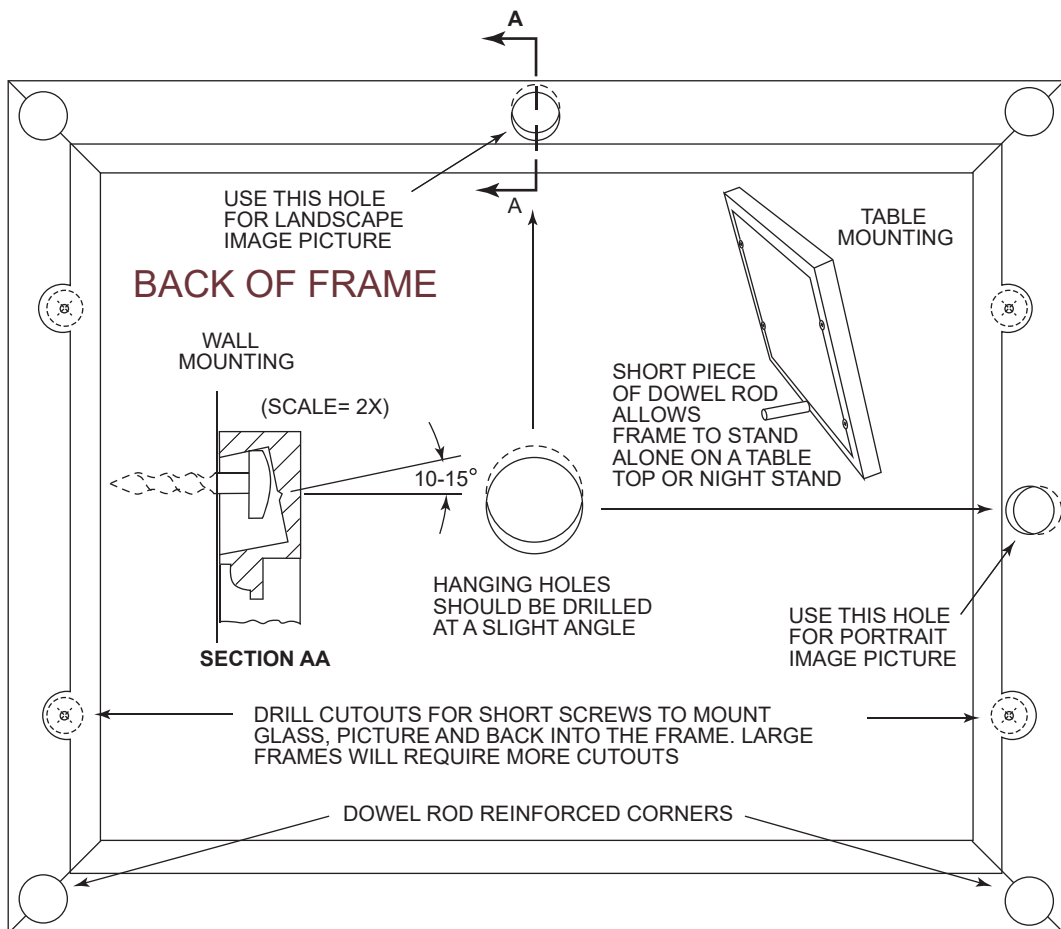
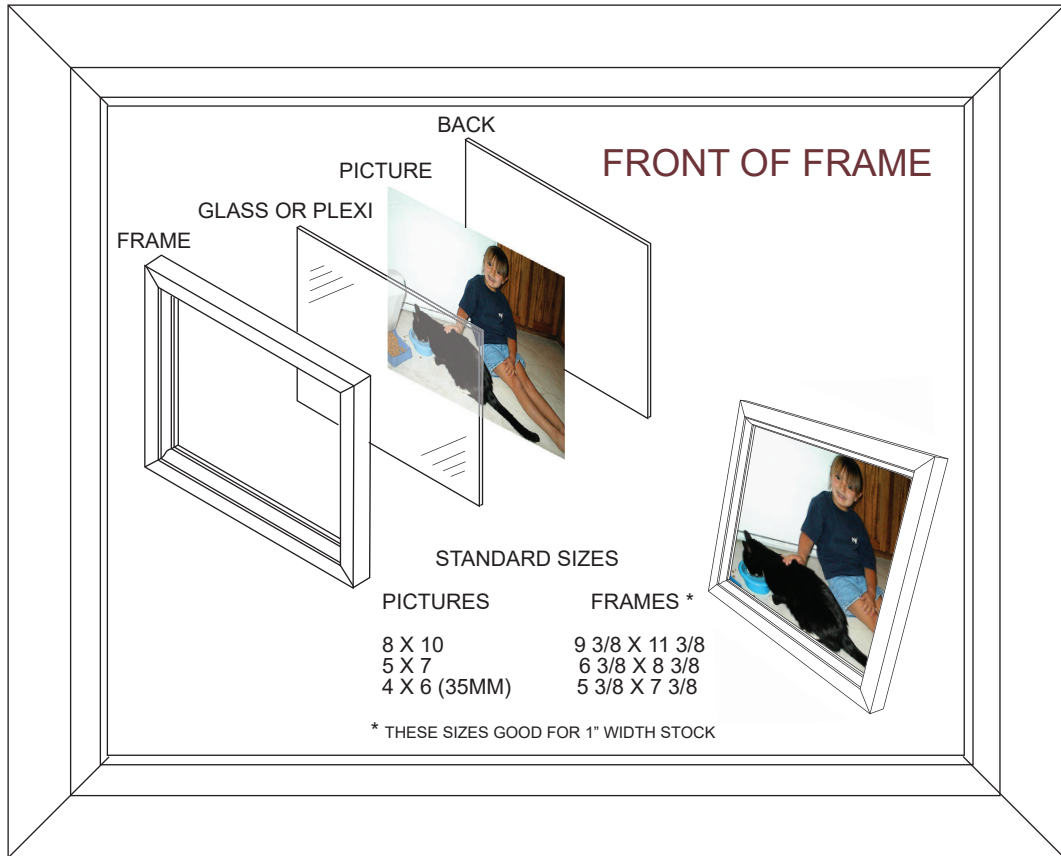

This page stolen directly from our "Picture and Story Frames" plans set.

More on this soon!



Artist Easel

Planner Holder

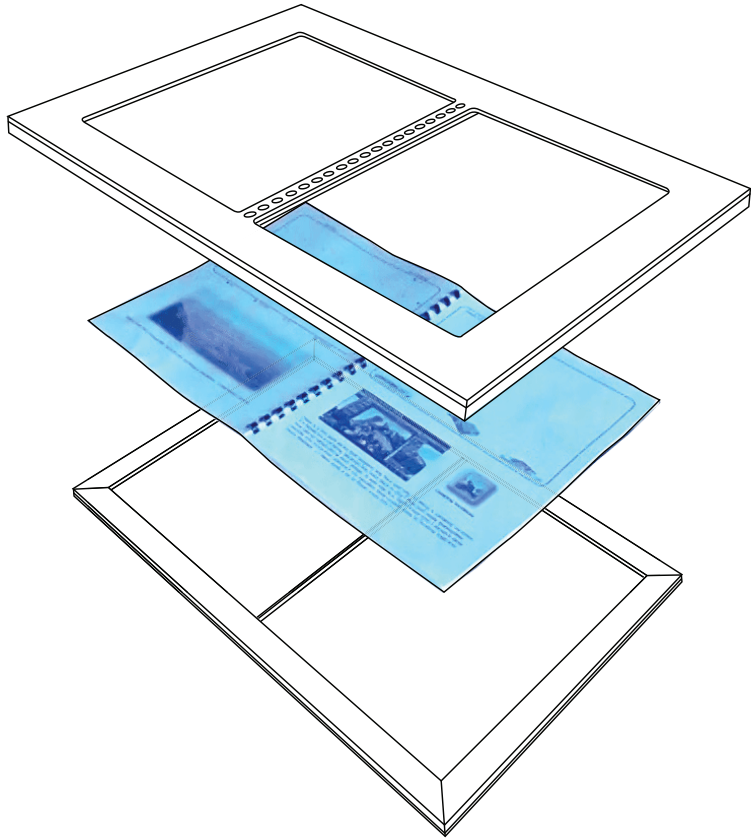

EXPLODED VIEW

This is a two piece planner holder. It's specifically designed for our Go Camping Calendar/planner (Can be download at www.camping-tips.com) but could be used for any spiral bound book printed on 8 1/2 x 11 stock.

It's meant to be a replacement for those big calendar pads that sit flat on a desk top. While those things are nice to have, they have not been designed to take with you. With this configuration your planner can be, camping or otherwise.

Your 'Desk Jokey' type folks might really appreciate this or something similar. I have the distinct feeling this notion is going to evolve into something a little different very shortly. I already have a few notions in mind.

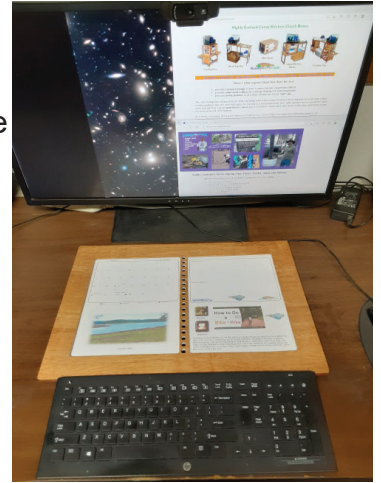

See what you can come up with but keep in mind the idea is a calendar on the desk that can also easily be taken somewhere else.

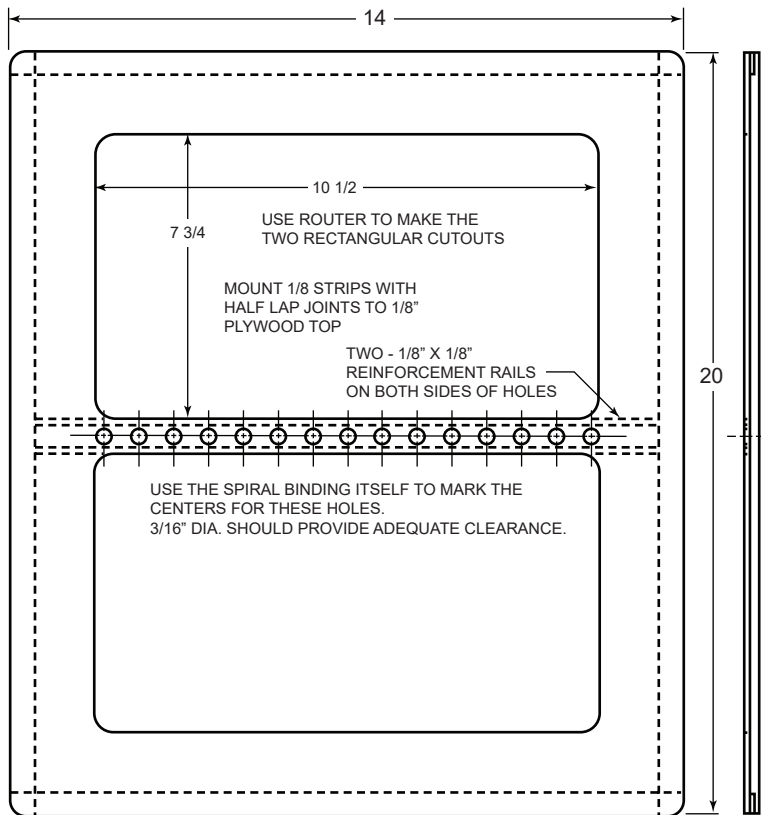

TOP

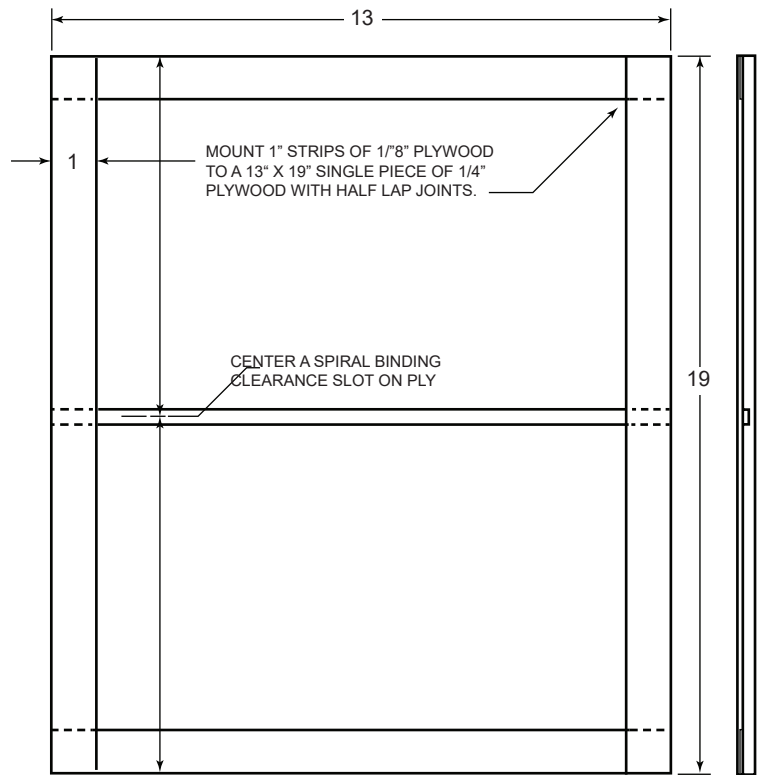

BASE

BASE MAY REQUIRE SANDING OR SLIGHT TRIMMING SO THE TOP CAN HAVE ENOUGH CLEARANCE TO SLIDE OVER THE BASE